

Directions: Color, cut and paste the images to the matching letter.

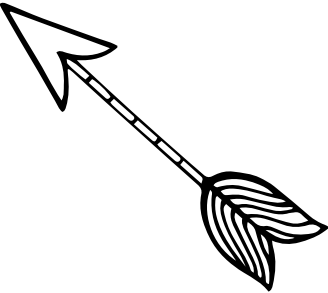

Directions: Color, cut and paste the images to the matching letter.

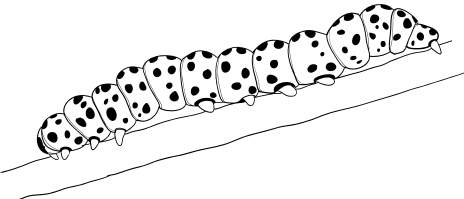
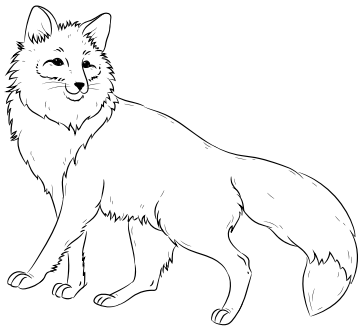
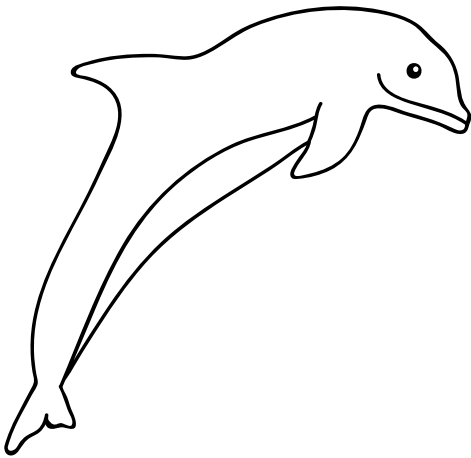
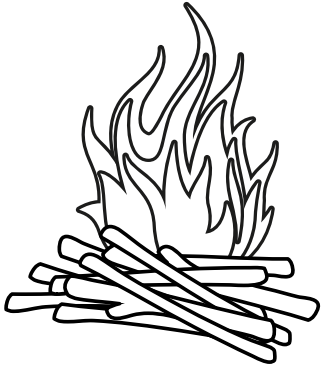
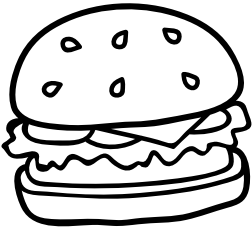
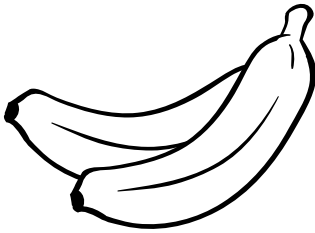
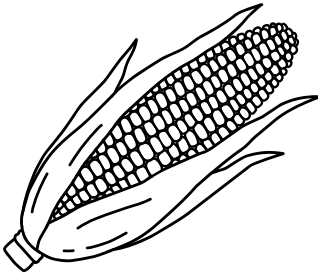
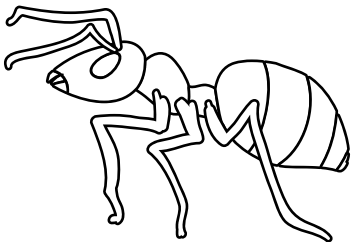
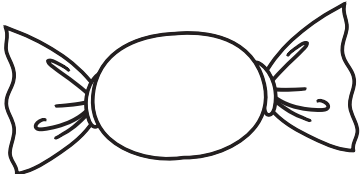
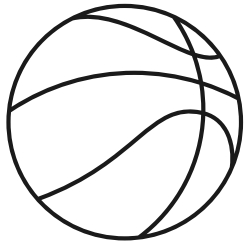
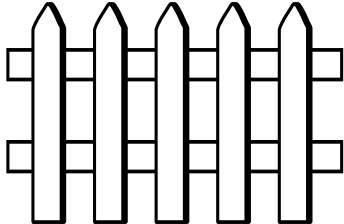
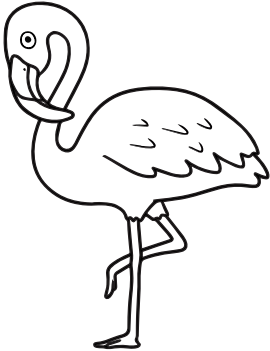
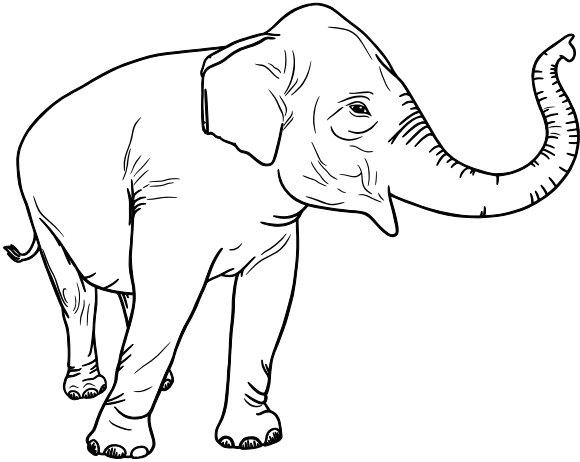
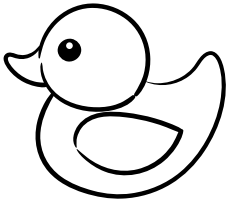
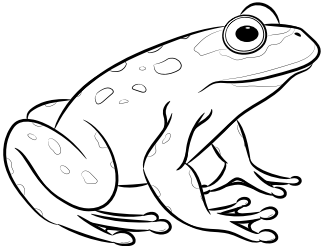
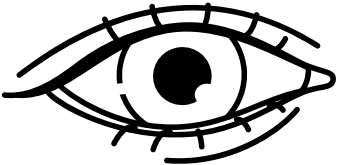
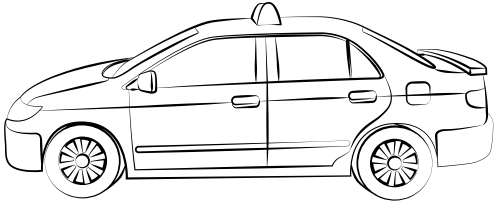
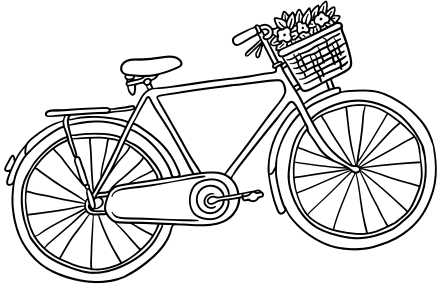

Directions: Color, cut and paste the images to the matching letter.

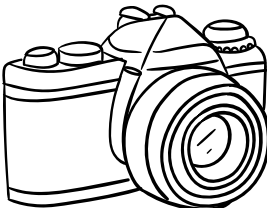
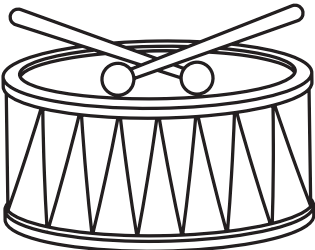
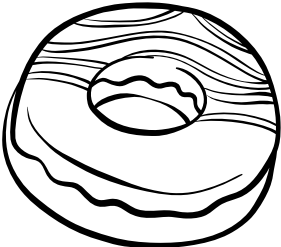
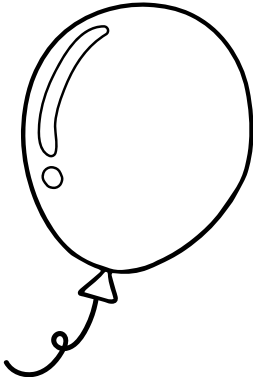
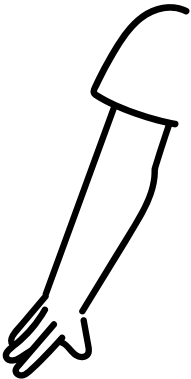
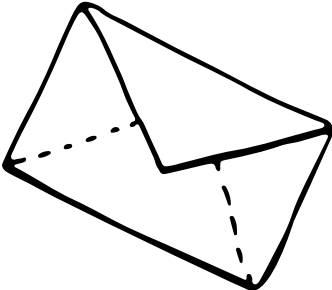
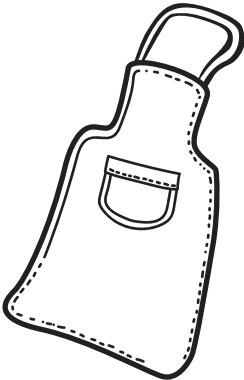
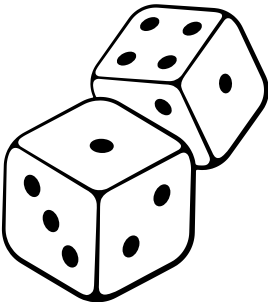
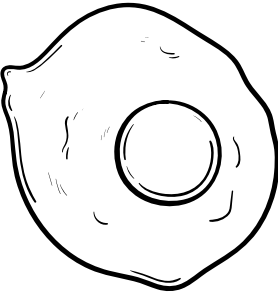
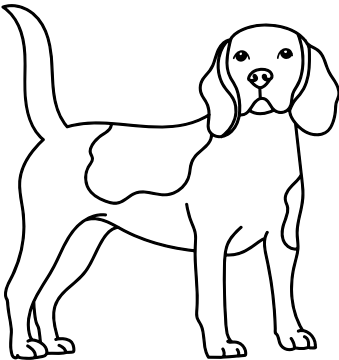
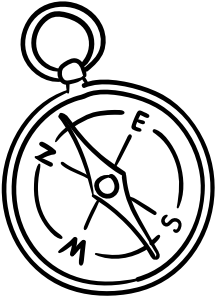

Directions: Color, cut and paste the images to the matching letter.

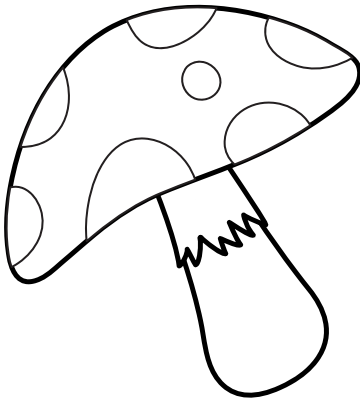
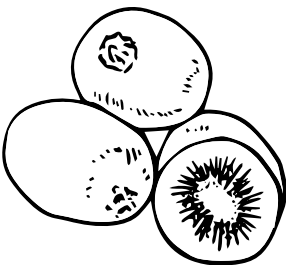
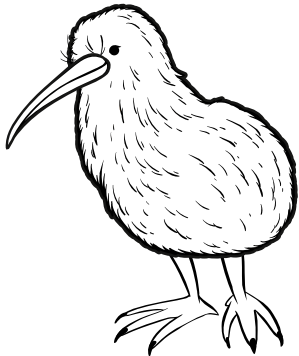
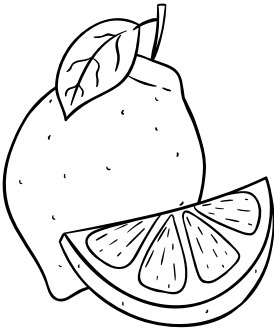
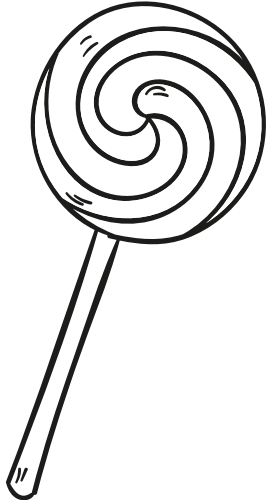
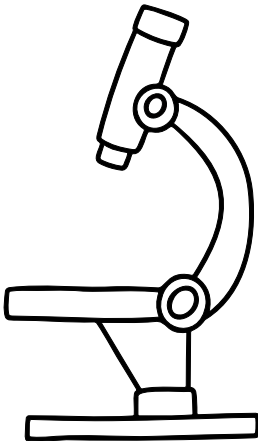
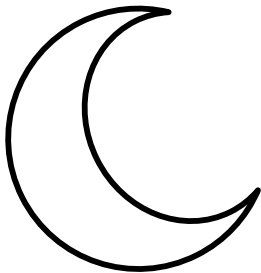
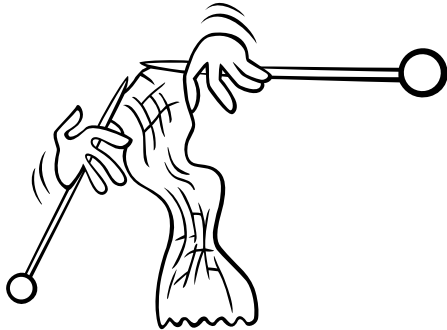

Directions: Color, cut and paste the images to the matching letter.

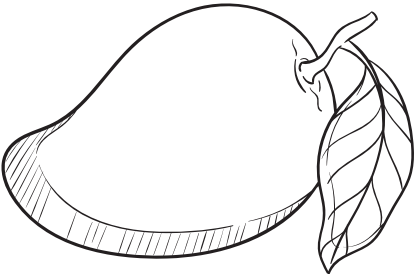
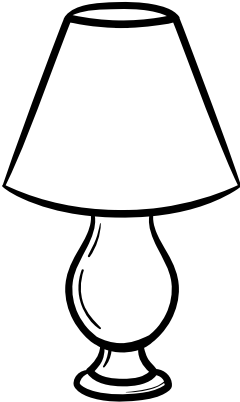
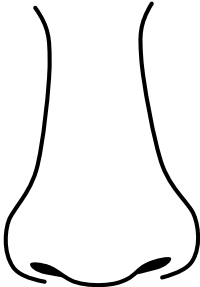
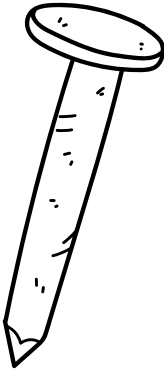
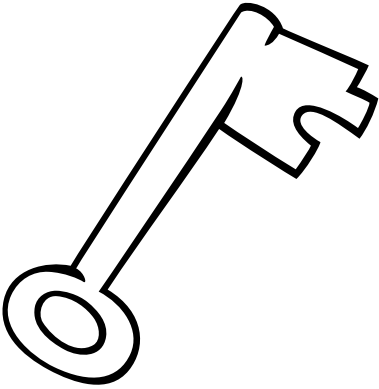
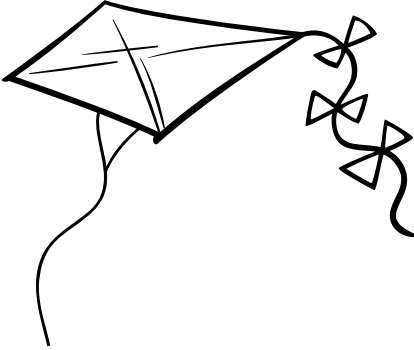
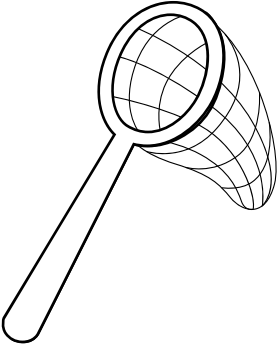
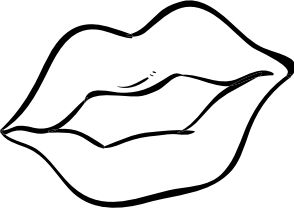
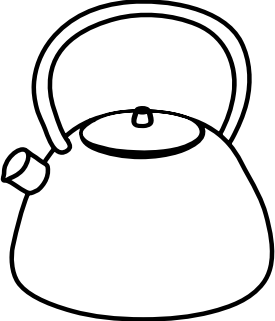

Directions: Color, cut and paste the images to the matching letter.

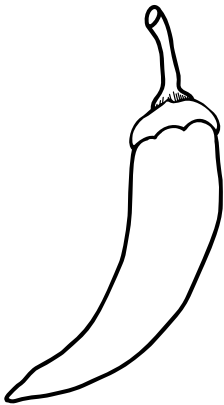
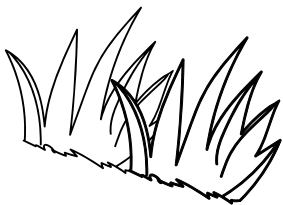
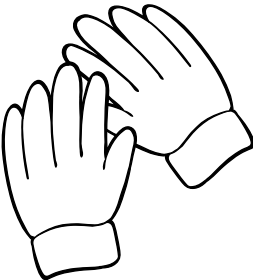
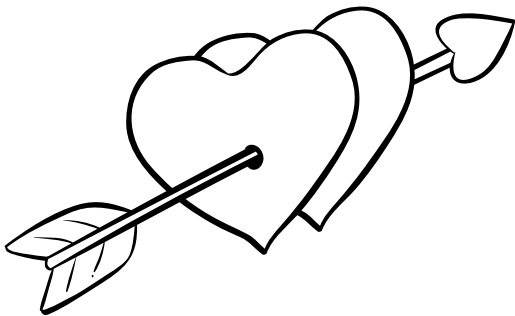
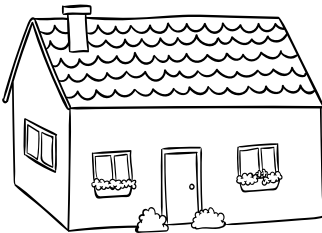
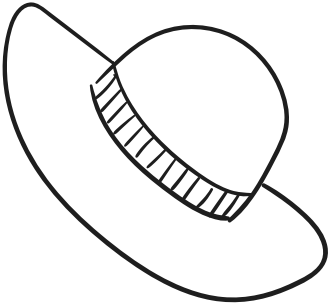
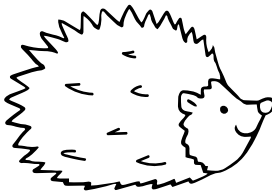
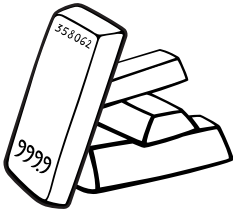
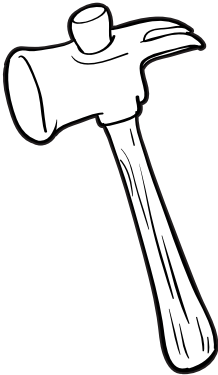
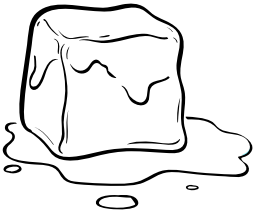
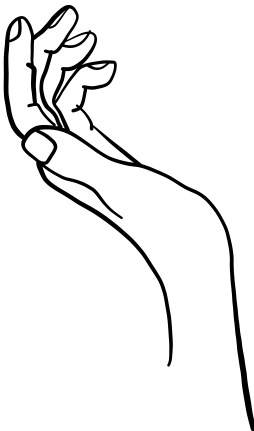
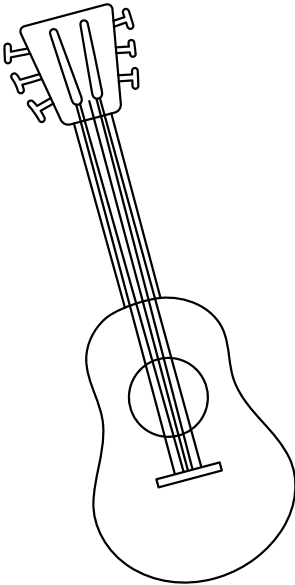

Directions: Color, cut and paste the images to the matching letter.

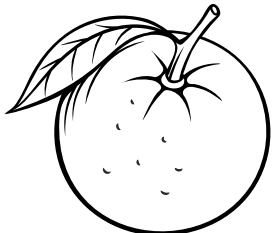
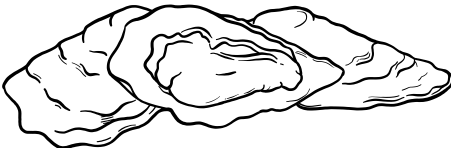
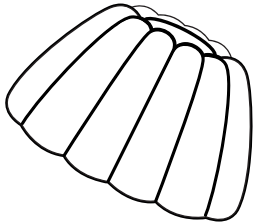
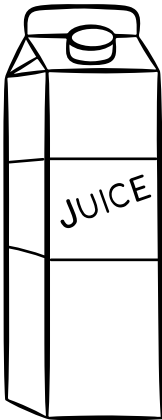
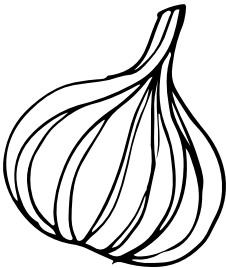
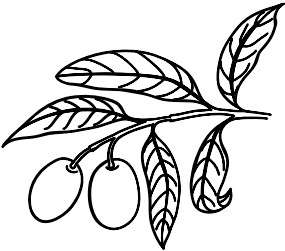
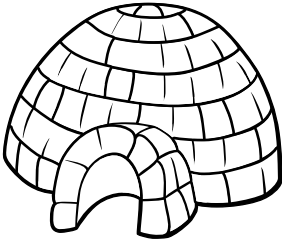

Directions: Color, cut and paste the images to the matching letter.

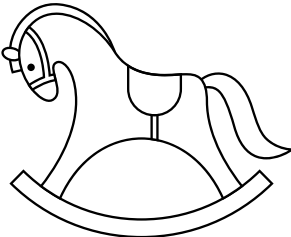
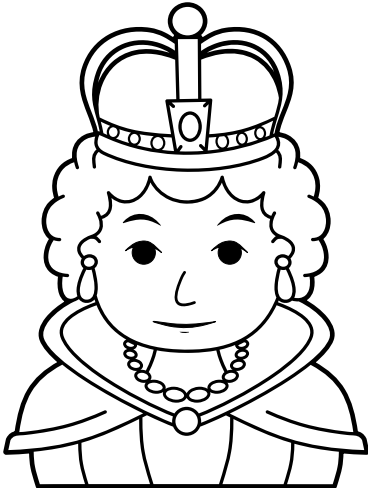
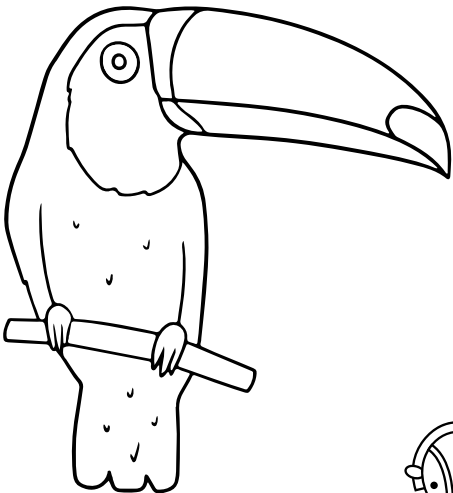
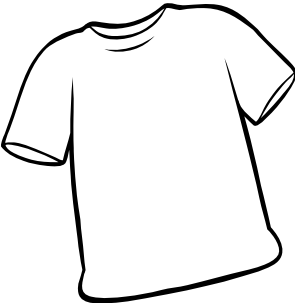
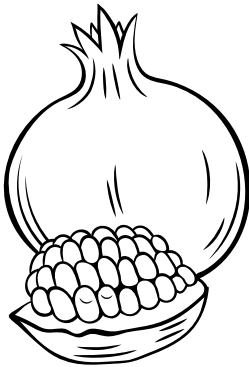
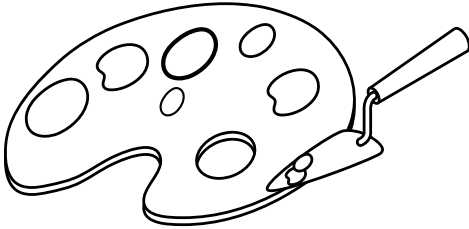
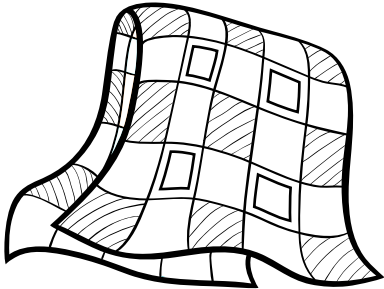
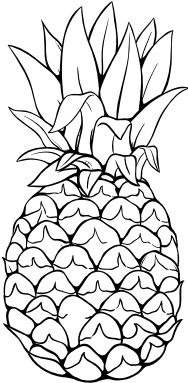

Directions: Color, cut and paste the images to the matching letter.

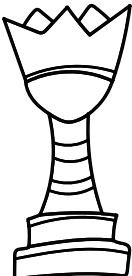
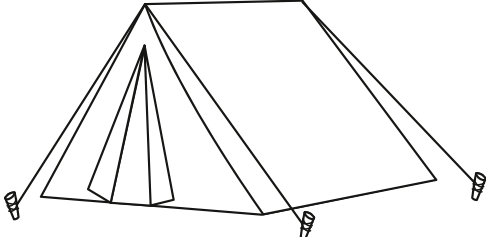
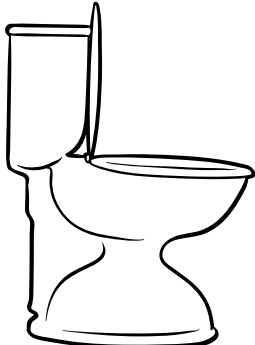
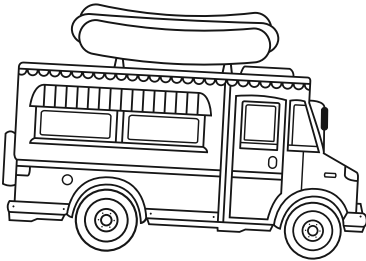
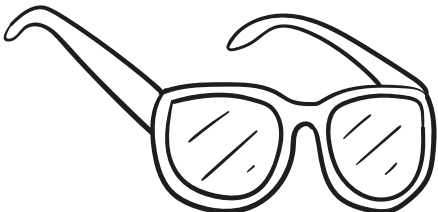
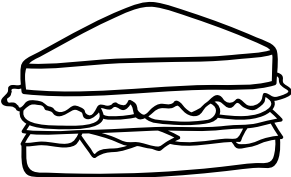
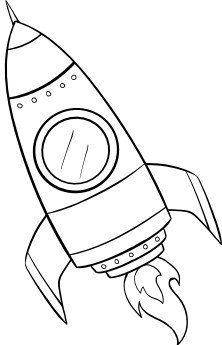
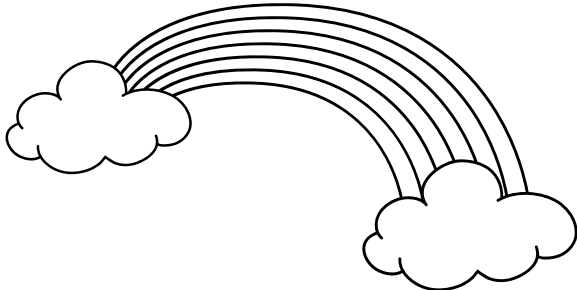
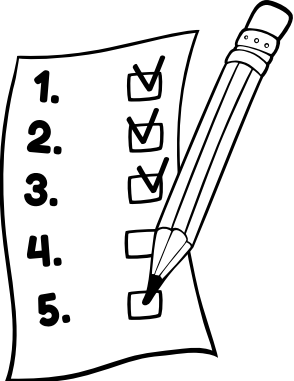
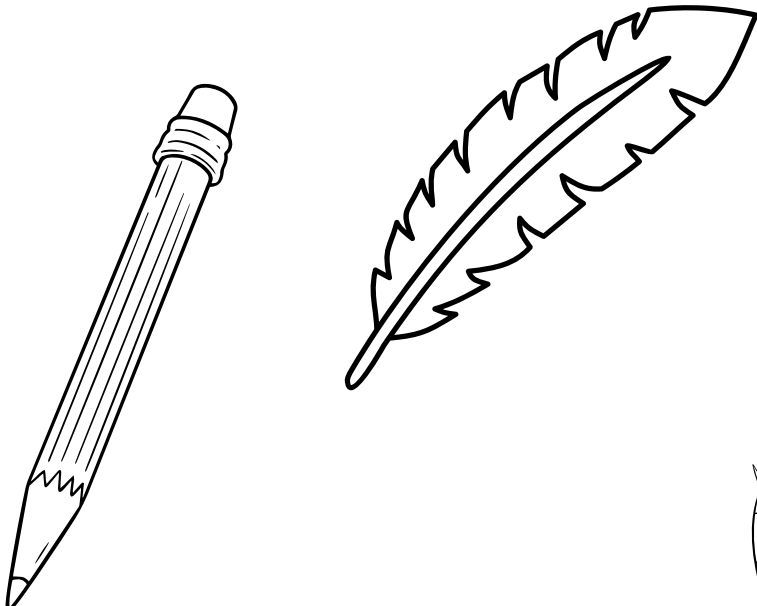

Directions: Color, cut and paste the images to the matching letter.

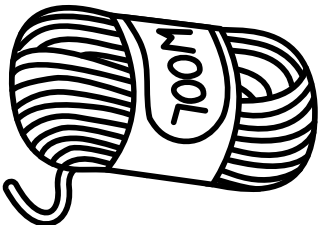
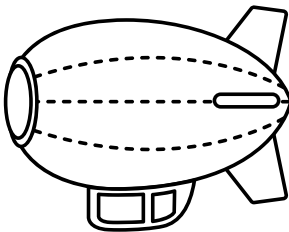
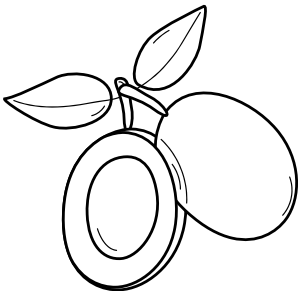
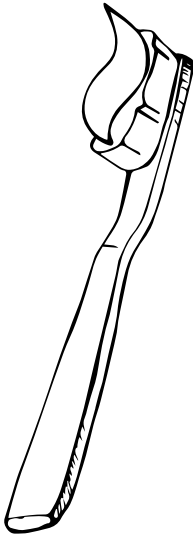
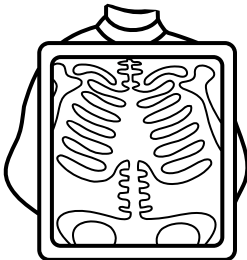
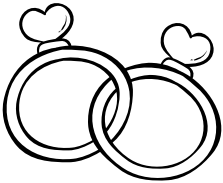
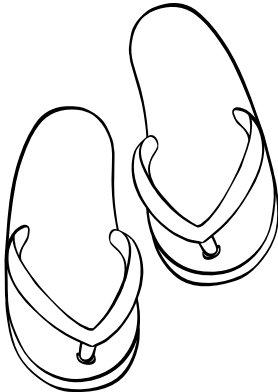
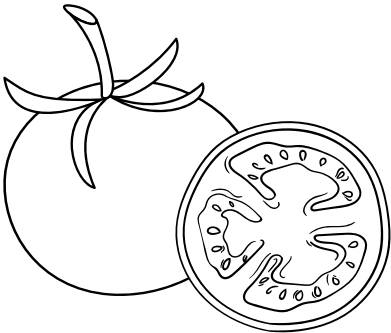
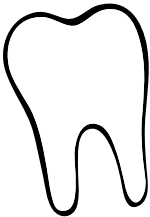
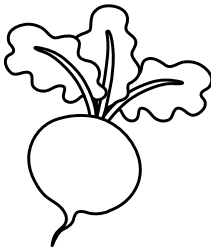
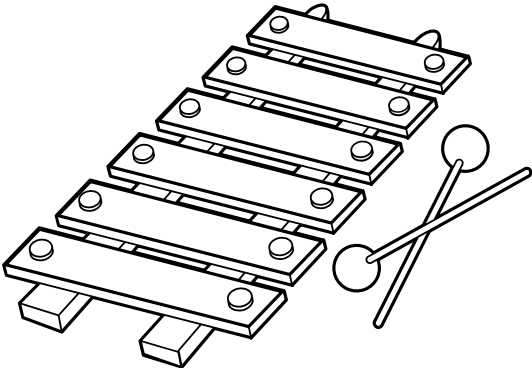
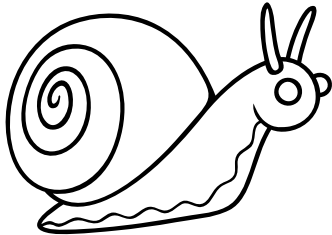
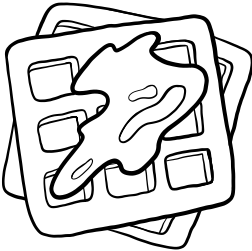
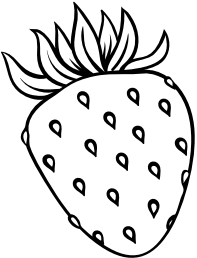

Directions: Color, cut and paste the images to the matching letter.

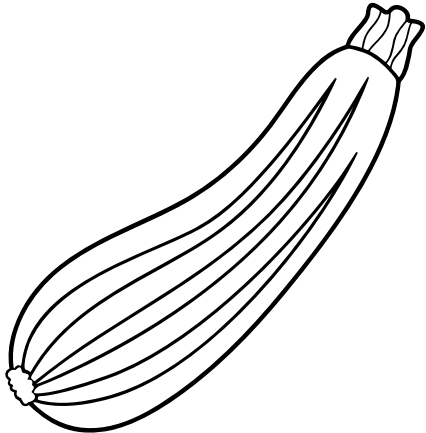
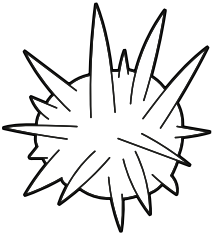
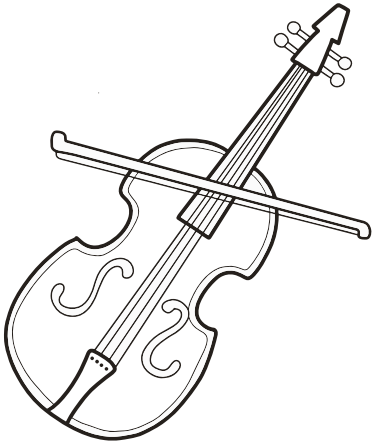
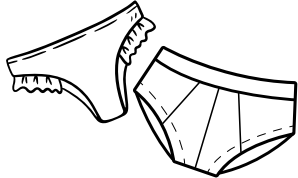
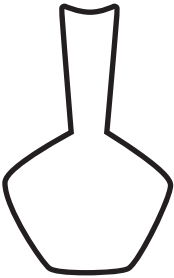
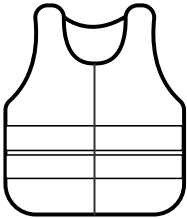
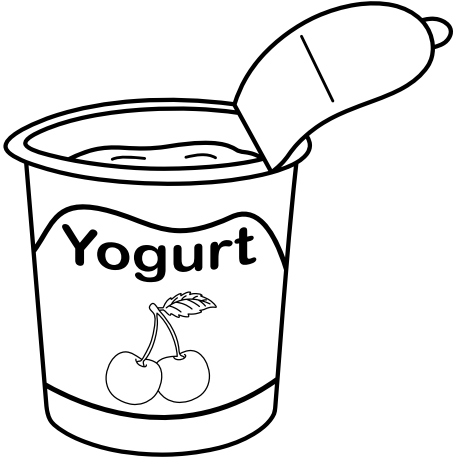
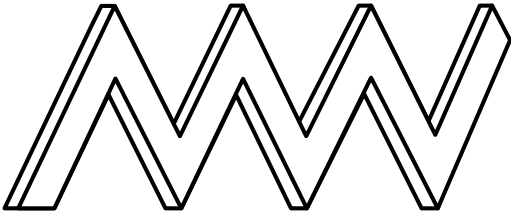
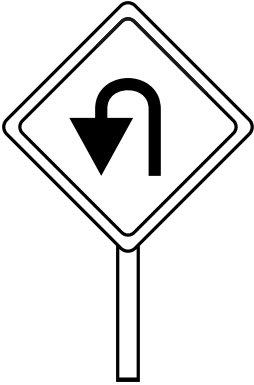

Directions: Color, cut and paste the images to the matching letter.

