

FIRE STATION

How To Draw

Directions: Follow the steps and trace the broken lines.

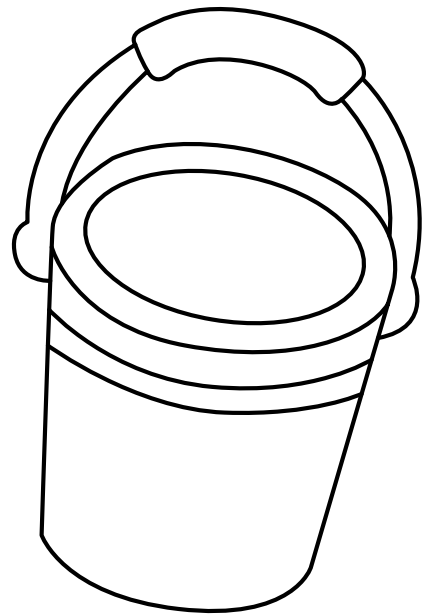

Step 1



Step 2

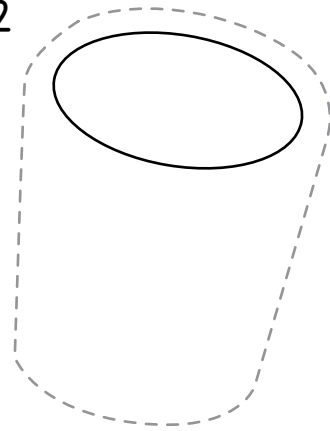

Step 3

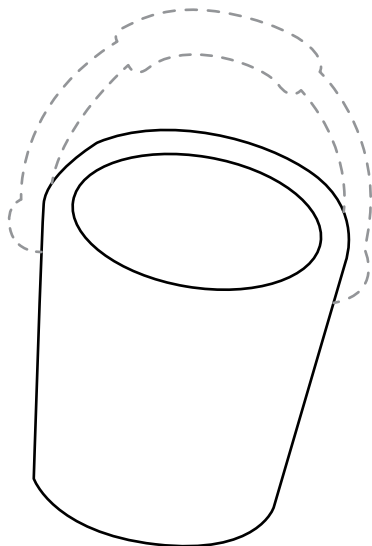

Step 4

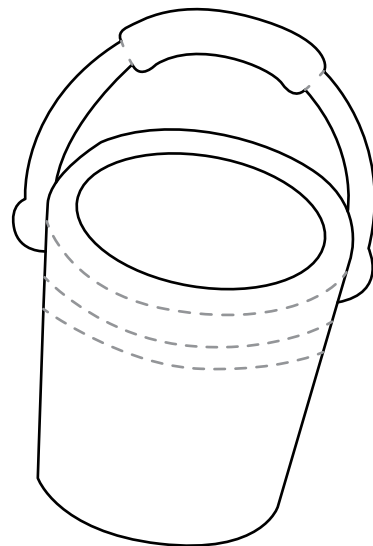

FIRE STATION

How To Draw

Directions: Follow the steps and trace the broken lines.

Step 1



Step 2

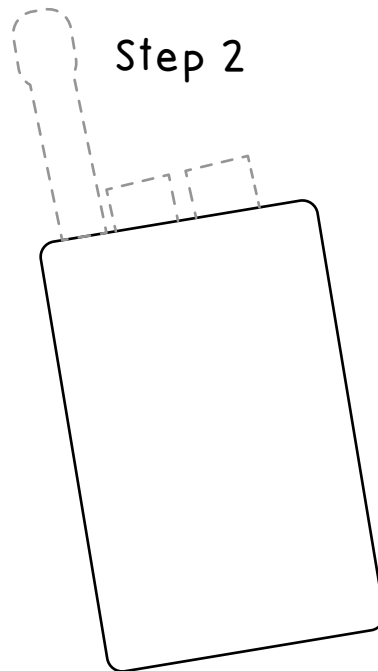

Step 3

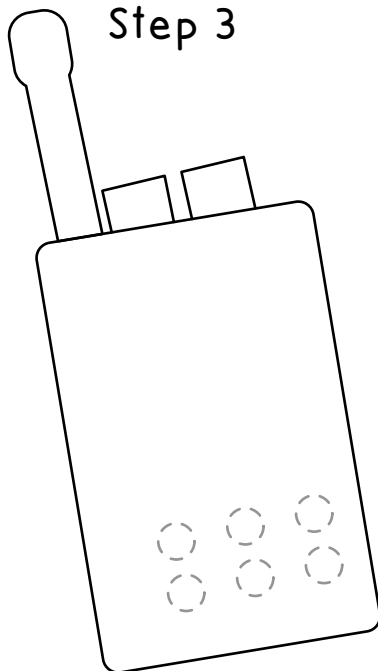

Step 4

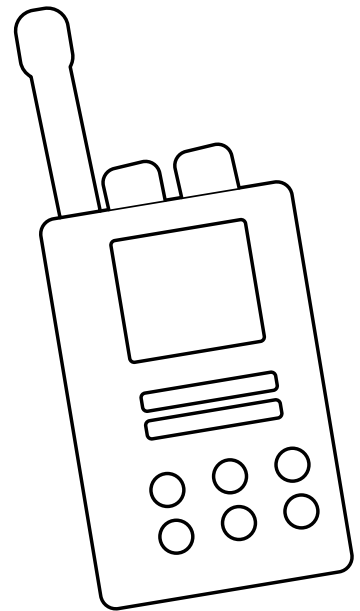
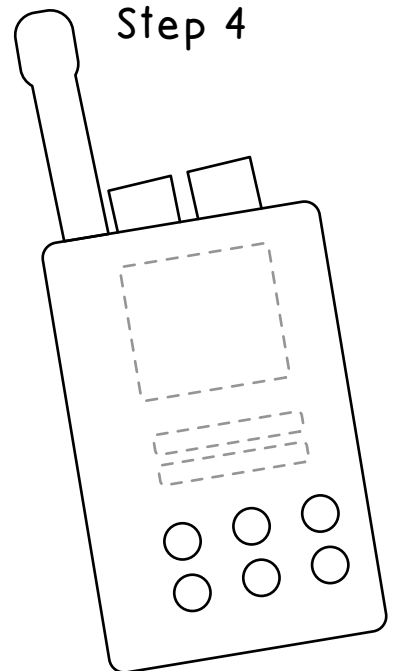

FIRE STATION

How To Draw

Directions: Follow the steps and trace the broken lines.

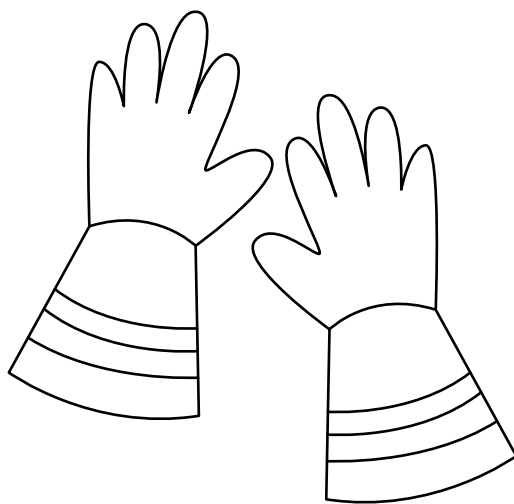

Step 1



Step 2

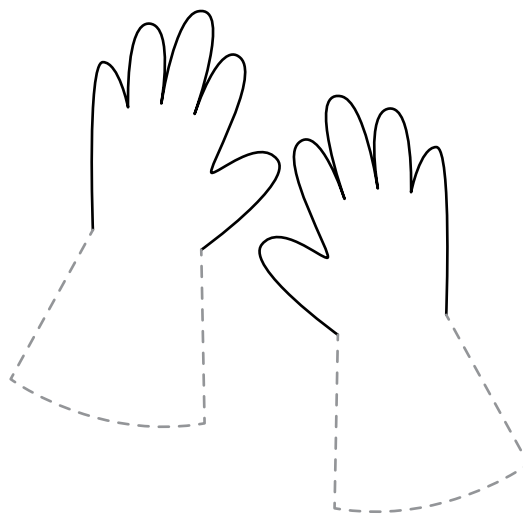

Step 3

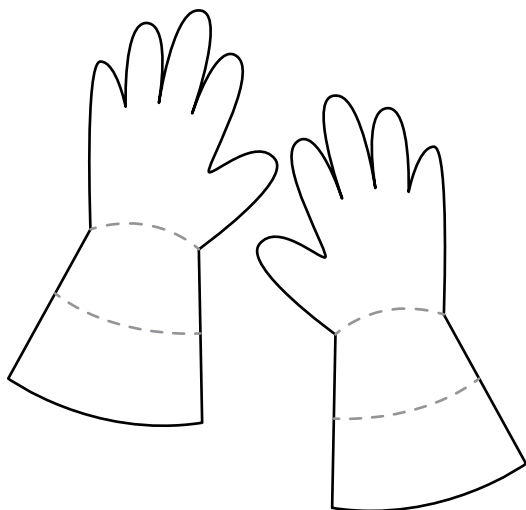

Step 4



FIRE STATION

How To Draw

Directions: Follow the steps and trace the broken lines.

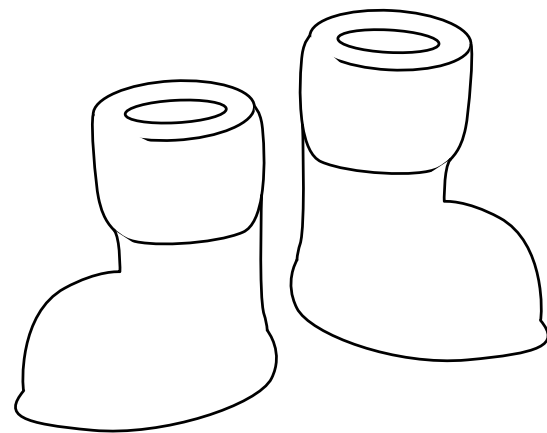

Step 1



Step 2

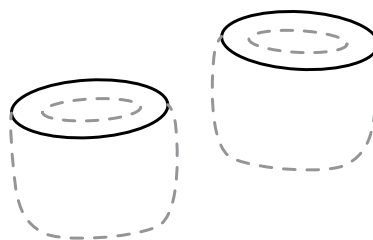

Step 3

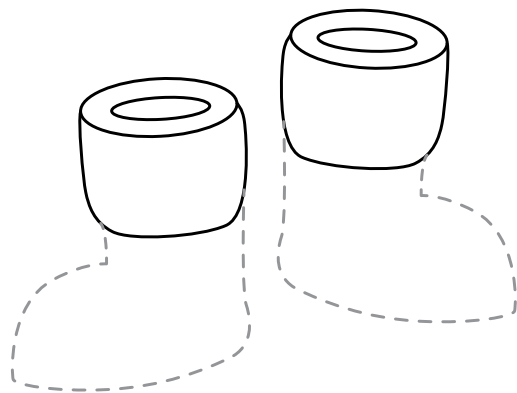

Step 4

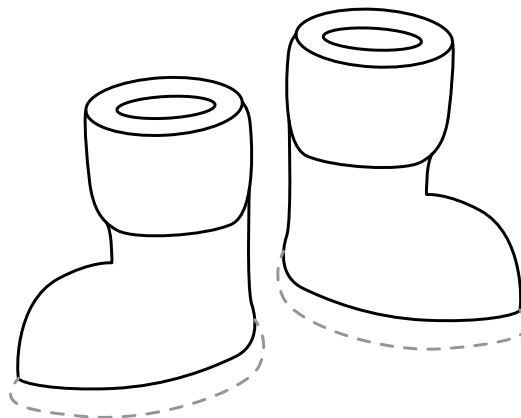

FIRE STATION

How To Draw

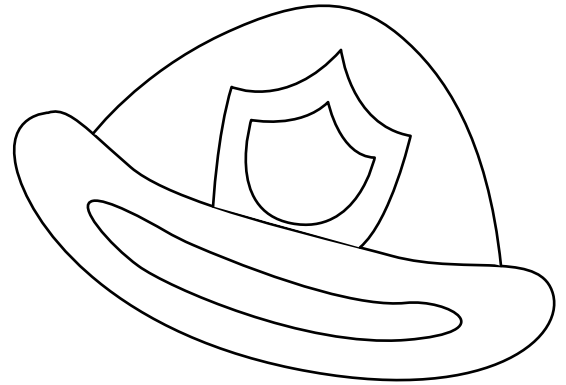

Directions: Follow the steps and trace the broken lines.

Step 1

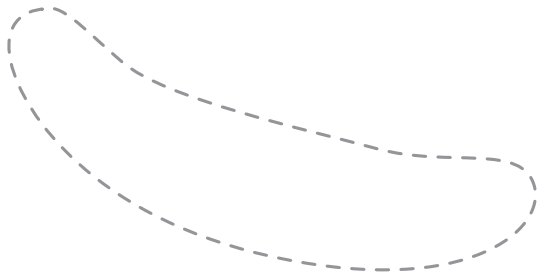

Step 2

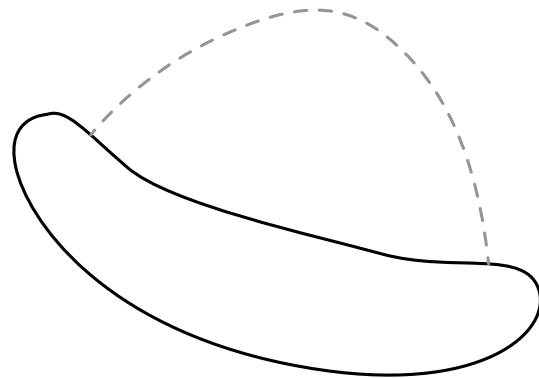

Step 3

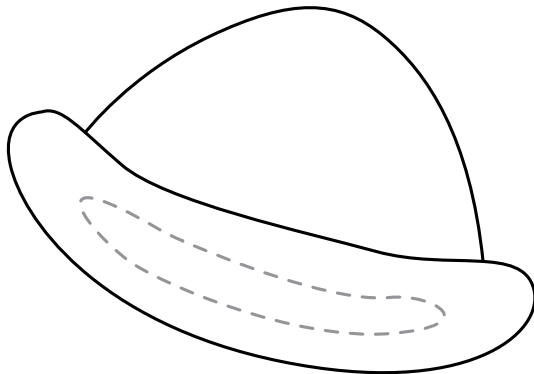

Step 4

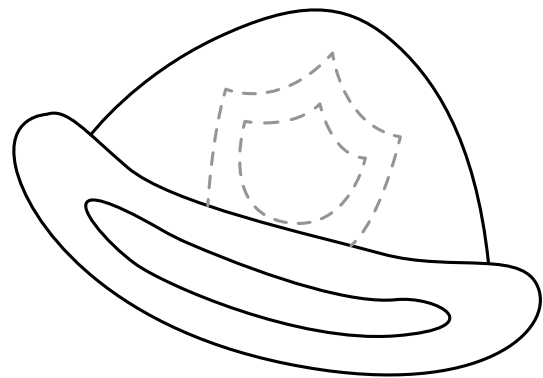

FIRE STATION

How To Draw

Directions: Follow the steps and trace the broken lines.

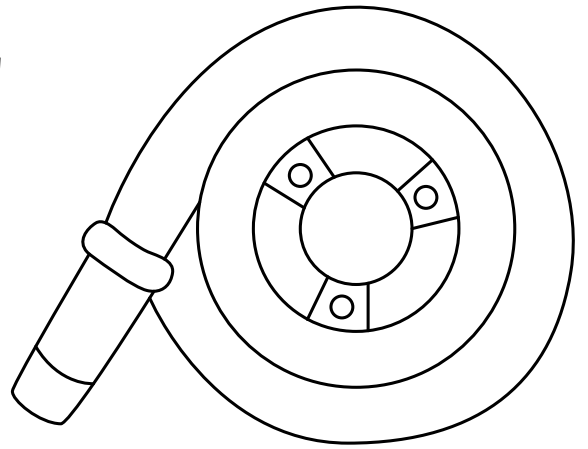

Step 1

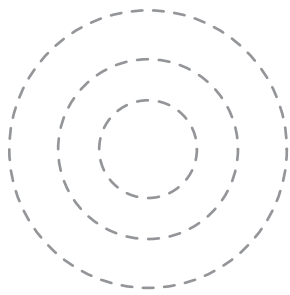

Step 2

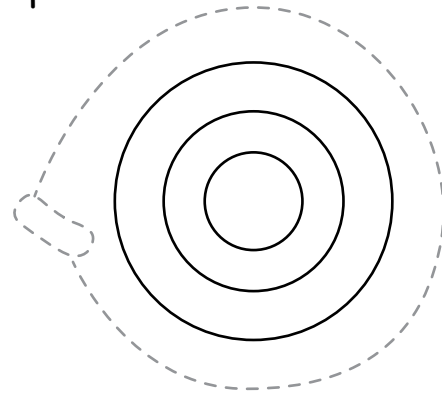

Step 3

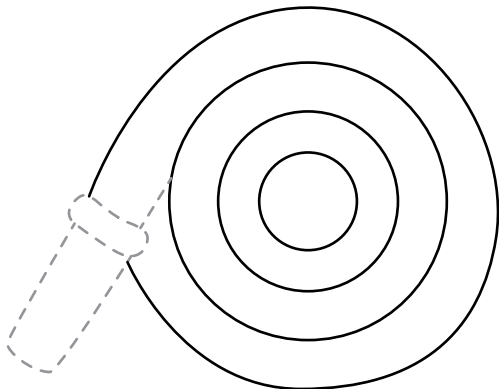

Step 4

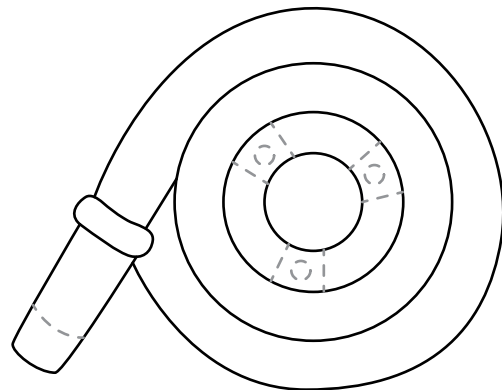

FIRE STATION

How To Draw

Directions: Follow the steps and trace the broken lines.

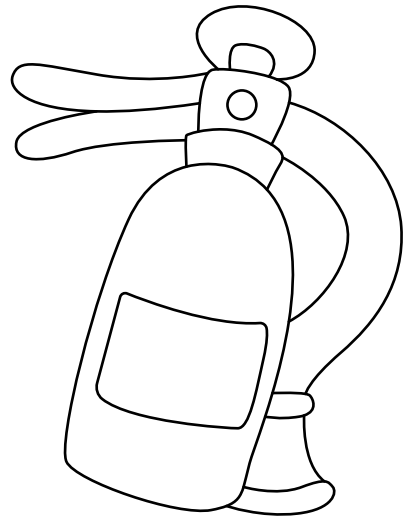

Step 1

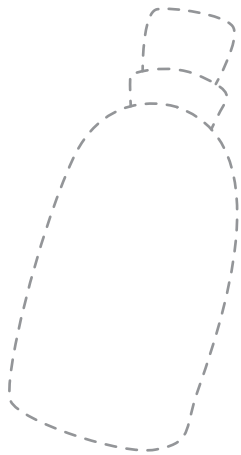

Step 2

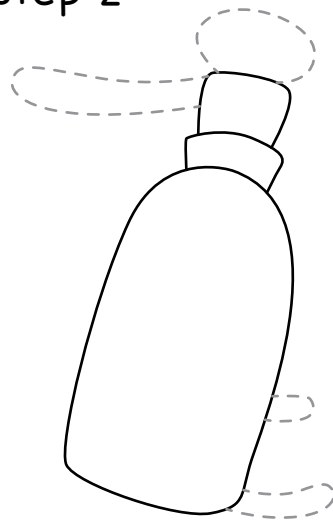

Step 3

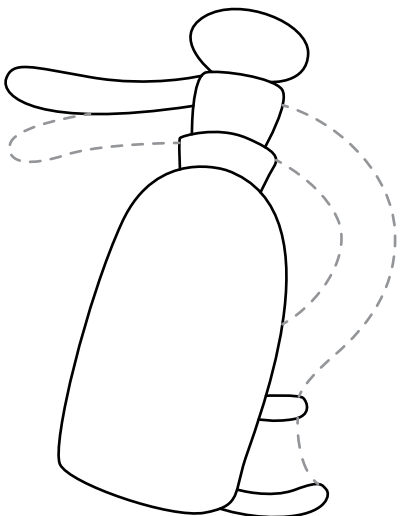

Step 4

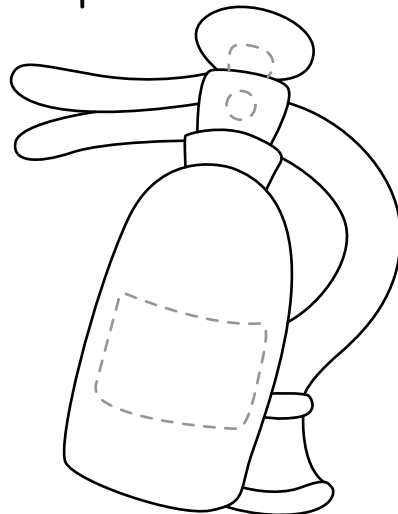

FIRE STATION

How To Draw

Directions: Follow the steps and trace the broken lines.

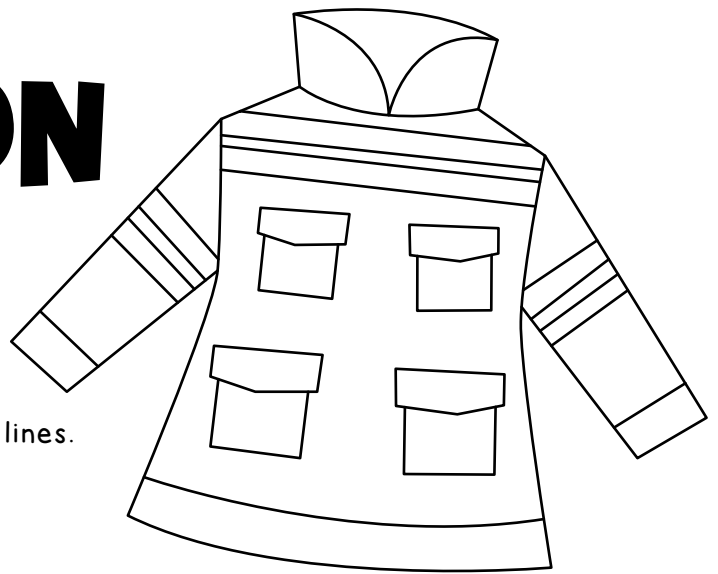

Step 1

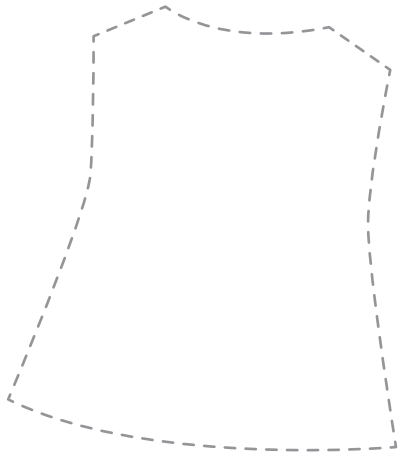

Step 2

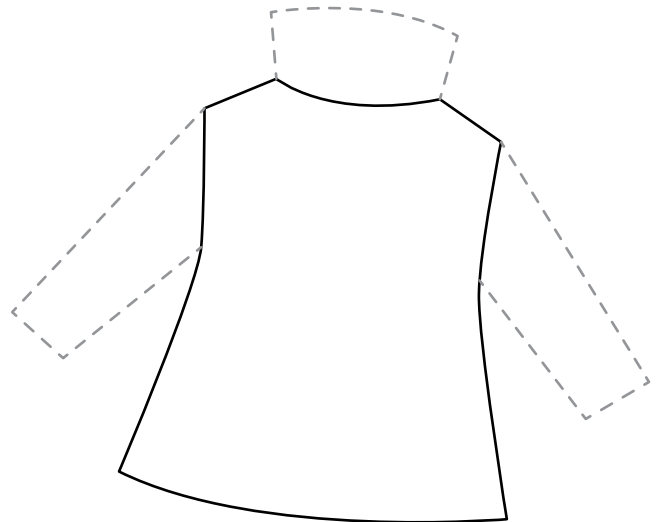

Step 3

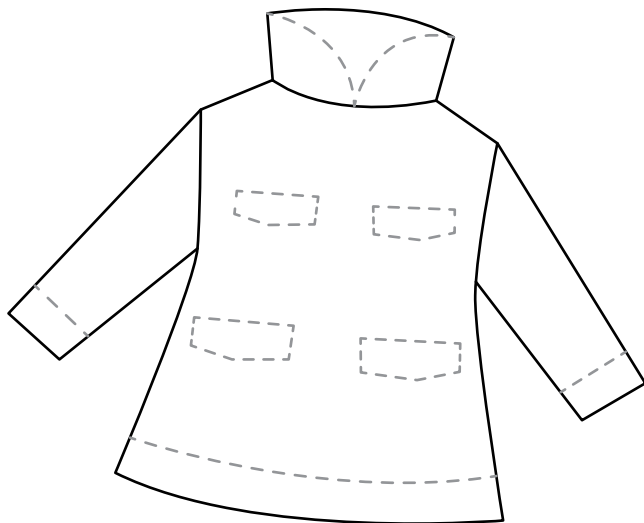

Step 4

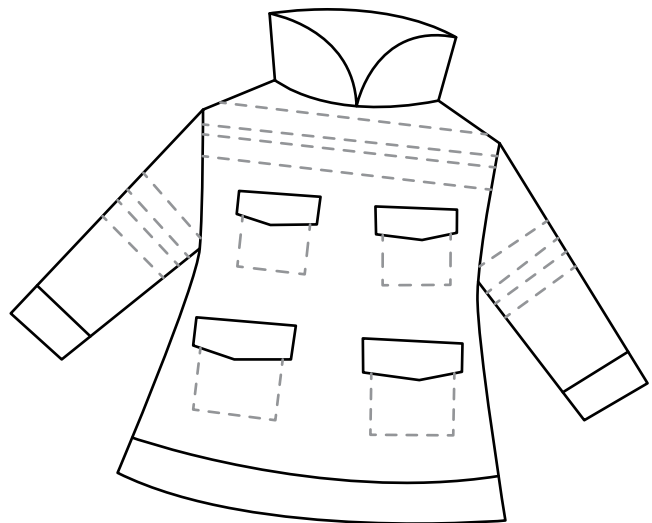

FIRE STATION

How To Draw

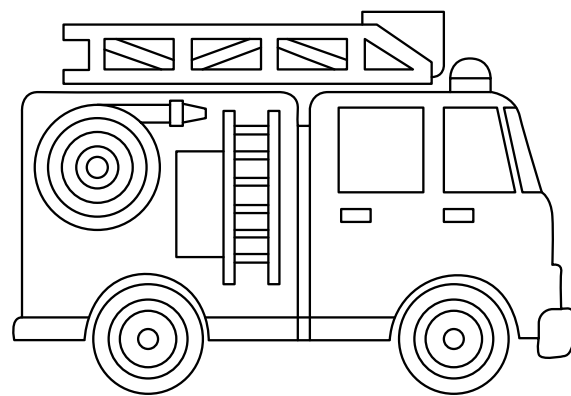

Directions: Follow the steps and trace the broken lines.

Step 1



Step 2

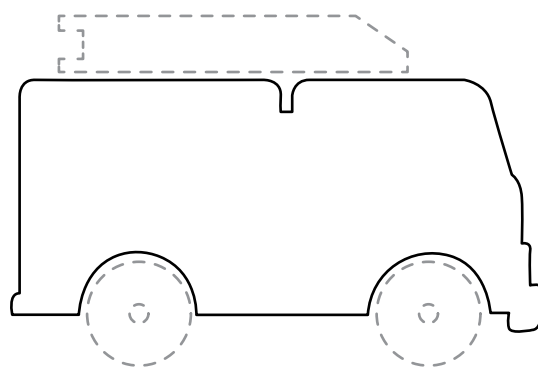

Step 3

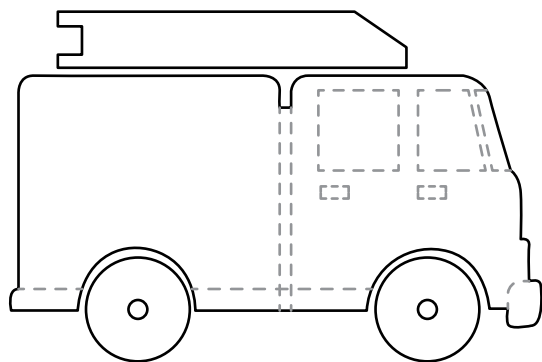

Step 4

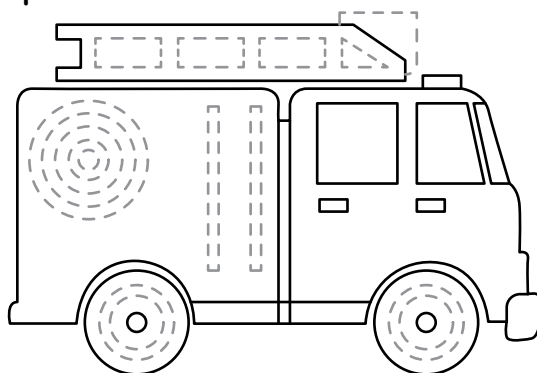

Step 5

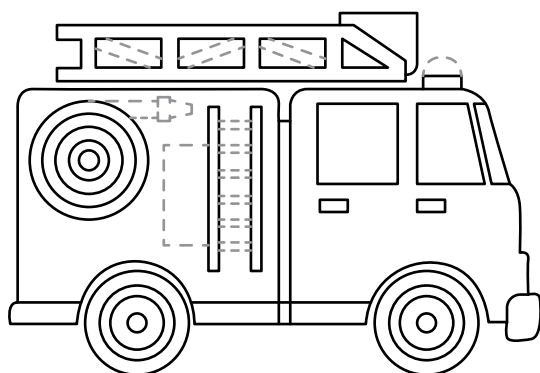

FIRE STATION

How To Draw

Directions: Follow the steps and trace the broken lines.

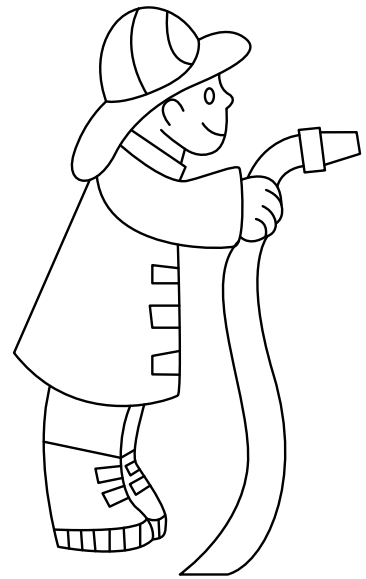

Step 1



Step 2

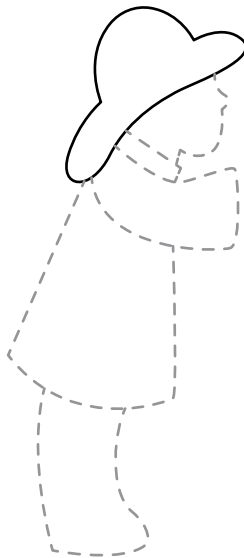

Step 3

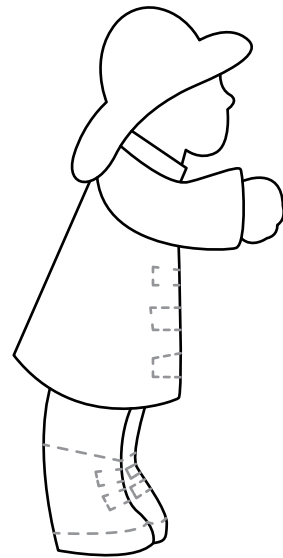

Step 4

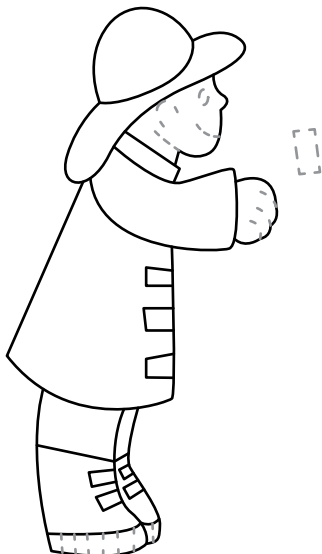

Step 5

